

SDURB15U120 ULTRAFAST RECTIFIER

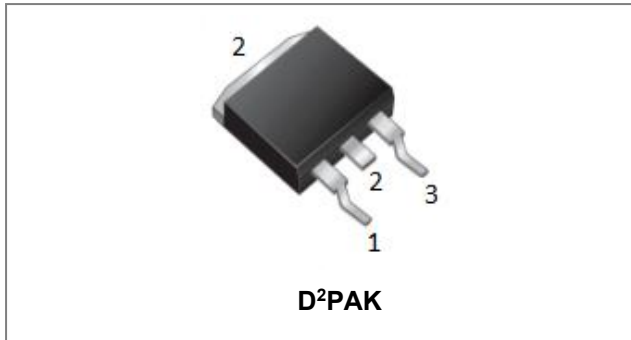

Applications

- Antiparallel diode for high frequency switching devices
- Anti saturation diode
- Snubber diode
- Free wheeling diode in converters and motor control circuits
- Rectifiers in switch mode power supplies (SMPS)
- Inductive heating and melting
- Uninterruptible power supplies (UPS)
- Ultrasonic cleaners and welders

Circuit Diagram

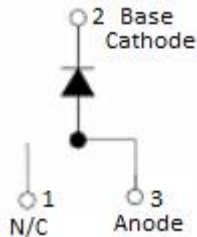

Features

- Ultra-Fast switching
- High current capability
- Low reverse leakage current
- High surge current capability
- This is a Pb – free device
- All SMC parts are traceable to the wafer lot
- Additional testing can be offered upon request

Maximum Ratings (limiting values, at 25 °C unless otherwise specified)

Characteristics	Symbol	Condition	Max.	Units
Peak Repetitive Reverse Voltage Working Peak Reverse Voltage DC Blocking Voltage	V_{RRM} V_{RWM} V_R	-	1200	V
Average Rectified Forward Current	$I_{F(AV)}$	50% duty cycle @ $T_c=140^\circ\text{C}$, rectangular wave form	15	A
Peak One Cycle Non-Repetitive Surge Current	I_{FSM}	8.3ms, Half Sine pulse	150	A

Electrical Characteristics:

Characteristics	Symbol	Condition	Typ.	Max.	Units
Forward Voltage Drop*	V_{F1}	@15A, Pulse, $T_J = 25^\circ\text{C}$	1.90	2.80	V
	V_{F2}	@15A, Pulse, $T_J = 150^\circ\text{C}$	1.50	2.30	V
Reverse Current*	I_{R1}	@ $V_R = \text{rated } V_R, T_J = 25^\circ\text{C}$	0.012	50	μA
	I_{R2}	@ $V_R = \text{rated } V_R, T_J = 150^\circ\text{C}$	22	250	μA
Reverse Recovery Time	t_{rr}	$I_F=500\text{mA}, I_R=1\text{A}, \text{ and } I_m=250\text{mA}$	46	50	ns
Reverse Recovery Time	t_{rr}	$I_F=15\text{A}, di_F/dt = -100\text{A}/\mu\text{s}, V_R=600\text{V}, T_J = 25^\circ\text{C}$	128	-	ns

* Pulse width < 300 μs , duty cycle < 2%

Thermal-Mechanical Specifications:

Characteristics	Symbol	Condition	Specification	Units
Junction Temperature	T_J	-	-65 to +175	$^{\circ}\text{C}$
Storage Temperature	T_{stg}	-	-65 to +175	$^{\circ}\text{C}$
Typical Thermal Resistance Junction to Ambient	$R_{\theta JA}$	DC operation	1.5	$^{\circ}\text{C}/\text{W}$
Approximate Weight	wt	-	1.85	g
Case Style	D ² PAK			

Ratings and Characteristics Curves

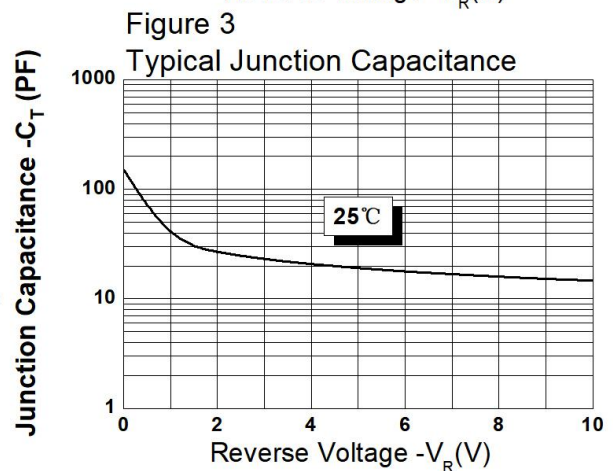
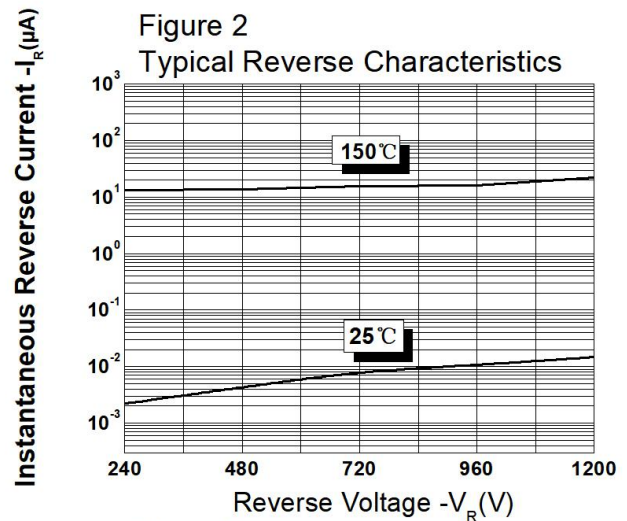
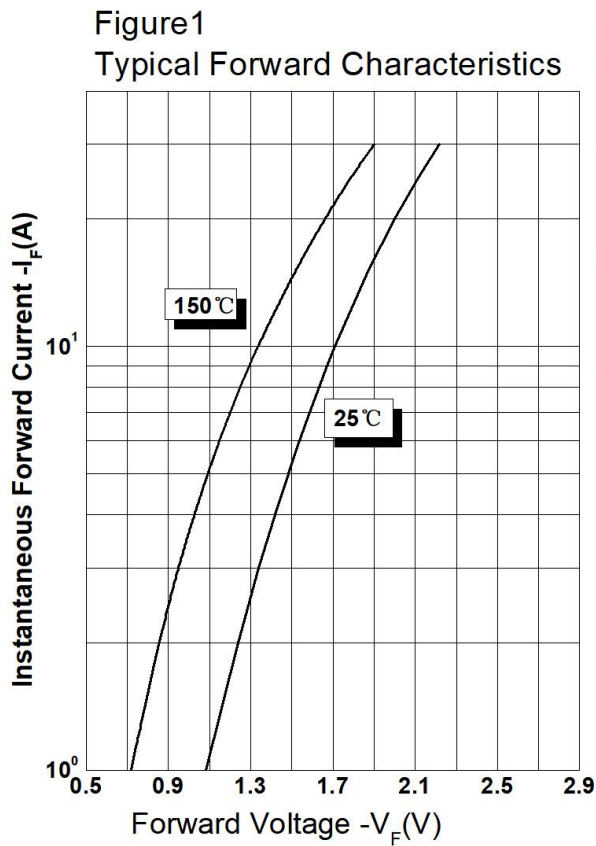

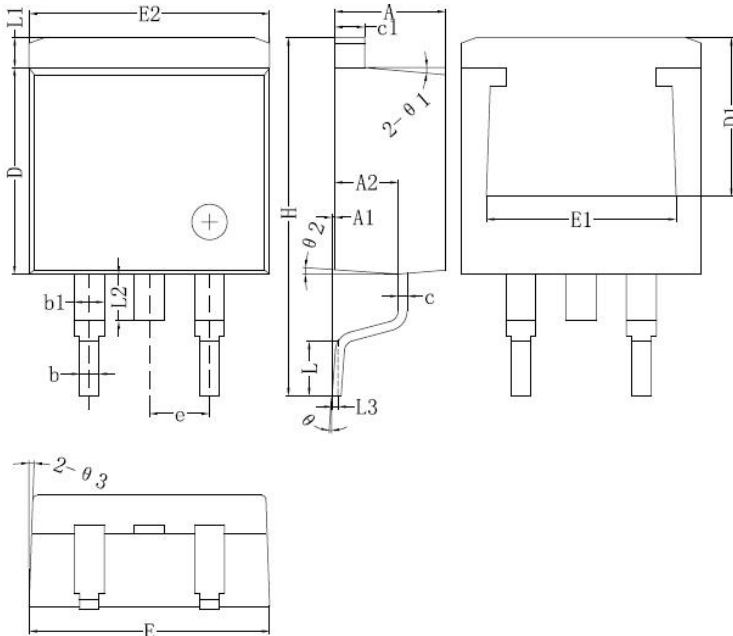
Mechanical Dimensions D²PAK

Symbol	Dimensions in millimeters	
	Min.	Max.
A	4.06	4.83
A1	0	0.26
b	0.51	0.99
b1	1.14	1.78
c	0.31	0.74
c1	1.14	1.65
D	8.38	9.65
D1	6.4	
E1	6.22	
E2	9.65	10.67
e	2.54BSC	
H	14.6	15.88
L	1.78	2.8
L1	-	1.68
L2	-	2.2
L3	0.255BSC	
Θ	0	8°

Ordering Information

Device	Package	Shipping
SDURB15U120	D ² PAK	800pcs / reel
SDURB15U120TR	D ² PAK	800pcs / reel

For information on tape and reel specifications, including part orientation and tape sizes, please refer to our tape and reel packaging specification.

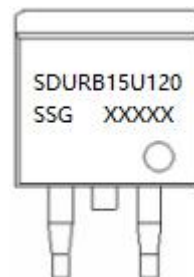
Marking Diagram

Where XXXXX is YYWWL

SDUR = Device Type
 B = Package type
 15 = Forward Current (15A)
 U = U
 120 = Reverse Voltage(1200V)
 SSG = SSG
 YY = Year
 WW = Week
 L = Lot Number

Cautions: Molding resin
 Epoxy resin UL:94V-0

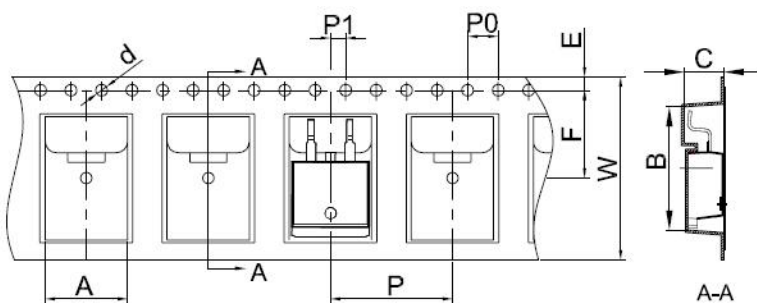
Carrier Tape Specification D²PAK

SYMBOL	Millimeters	
	Min.	Max.
A	10.70	10.90
B	16.03	16.23
C	5.11	5.31
d	1.45	1.65
E	1.65	1.85
F	11.40	11.60
P0	3.90	4.10
P	15.90	16.10
P1	1.90	2.10
W	23.90	24.30

DISCLAIMER:

1- The information given herein, including the specifications and dimensions, is subject to change without prior notice to improve product characteristics. Before ordering, purchasers are advised to contact the SMC Diode Solutions sales department for the latest version of the datasheet(s).

2- In cases where extremely high reliability is required (such as use in nuclear power control, aerospace and aviation, traffic equipment, medical equipment, and safety equipment), safety should be ensured by using semiconductor devices that feature assured safety or by means of users' fail-safe precautions or other arrangement.

3- In no event shall SMC Diode Solutions be liable for any damages that may result from an accident or any other cause during operation of the user's units according to the datasheet(s). SMC Diode Solution assumes no responsibility for any intellectual property claims or any other problems that may result from applications of information, products or circuits described in the datasheets.

4- In no event shall SMC Diode Solutions be liable for any failure in a semiconductor device or any secondary damage resulting from use at a value exceeding the absolute maximum rating.

5- No license is granted by the datasheet(s) under any patents or other rights of any third party or SMC Diode Solutions.

6- The datasheet(s) may not be reproduced or duplicated, in any form, in whole or part, without the expressed written permission of SMC Diode Solutions.

7- The products (technologies) described in the datasheet(s) are not to be provided to any party whose purpose in their application will hinder maintenance of international peace and safety nor are they to be applied to that purpose by their direct purchasers or any third party. When exporting these products (technologies), the necessary procedures are to be taken in accordance with related laws and regulations..